



## **Light Curtains**

Barriere ottiche

## **Light Curtains Accessories**

Accessori per barriere





**GIOVENZANA**  
**INTERNATIONAL B.V.**

**GIOVENZANA INTERNATIONAL B.V.**

Strawinskylaan 1427, 1077 XX Amsterdam, The Netherlands  
Ph. +31(0)20.4413576 | Fax +31(0)20.4413456 | [giovenzana@giovenzana.com](mailto:giovenzana@giovenzana.com)

**[www.giovenzana.com](http://www.giovenzana.com)**



# Light curtains CL Series

Light curtains for elevators and elevating platforms EN81-20



# Barriere ottiche Serie CL

Barriere ottiche per ascensori e piattaforme elevatrici EN81-20

Light curtains  
Barriere ottiche

Light curtains accessories  
Accessori per barriere

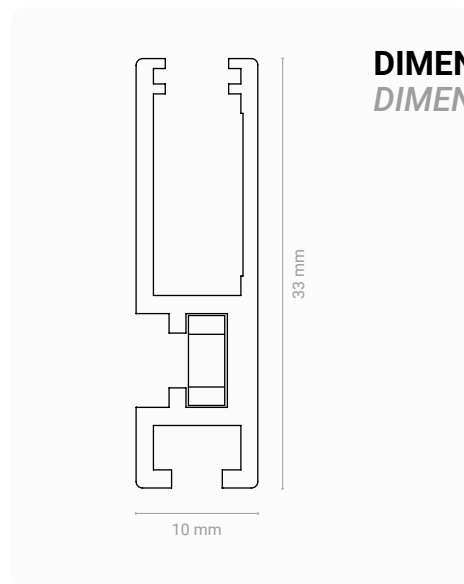
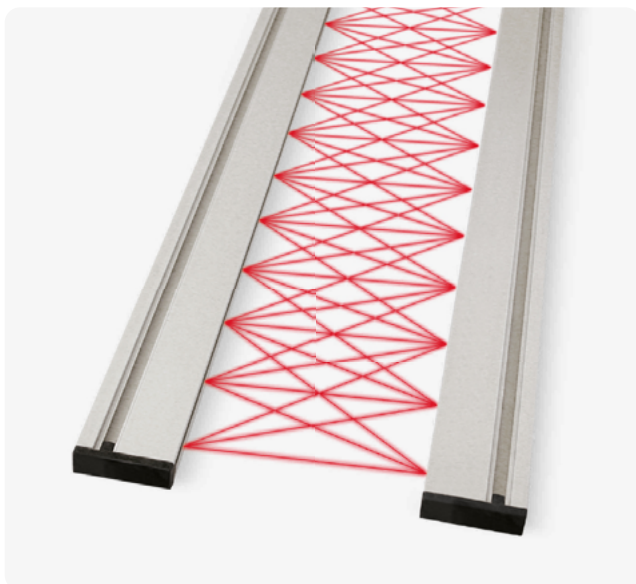

**DIMENSIONS**  
DIMENSIONI



**IP44**

- Extremely easy to install
- Fixing with two screws using sliding nuts in the profile
- Very easy alignment between TX and RX
- Suitable for static and dynamic installations
- High immunity against light and electromagnetic interferences
- Nudging: System to facilitate people flow with doors closing warning signal
- Autotest: Periodic diagnostics to ascertain correct operation of internal systems
- Buzzer: Warning audible signal with option to select the mode: Disabled or Enabled

- Estrema semplicità di installazione
- Fissaggio con due viti tramite dadi a scorrimento nel trafilato
- Ampia capacità di allineamento fra TX e RX
- Adatta per funzionamento statico o dinamico
- Altissima immunità a disturbi elettromagnetici e luminosi
- Nudging: Sistema per agevolazione del flusso delle persone con segnale di avvertimento chiusura porte
- Autotest: Diagnostica periodica per la verifica del corretto funzionamento dei sistemi interni
- Segnalazione acustica di avvertimento con possibilità di selezione della modalità: Esclusa o Attiva

## AVAILABLE MODELS MODELLI DISPONIBILI

Product Prodotto	Diodes q.ty N° diodi	Beams q.ty N° raggi	Operating range Portata	Light curtain height Altezza barriera	Protected height Area protetta	Power supply Alimentazione	Output Uscita	Nudging Door
<b>GBLCL194E</b>	40	194	0-3,5 mt	2000 mm	da 20 a 1830 mm	11 - 35V DC 10 - 30V AC * 220V AC	Relay Relè 1A 30V DC	Yes Sì
<b>GBLCL074E</b>	16	74		945 mm	da 20 a 700 mm			

\* Alimentazione a 220V con alimentatore AL-1 \* Supply 220V with AL-1 power supply



# Light curtains EL Series

Light curtains for elevators and elevating platforms EN81-20

## Barriere ottiche Serie EL

Barriere ottiche multiraggio per ascensori e piattaforme elevatrici EN81-20



Light curtains  
Barriere ottiche

Light curtains accessories  
Accessori per barriere

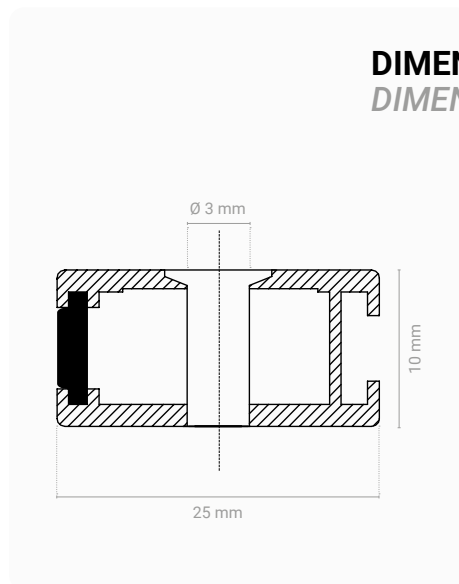

**DIMENSIONS**  
**DIMENSIONI**



- Extremely easy to install
- Very easy alignment between TX and RX
- Suitable for static and dynamic installations
- High immunity against light and electromagnetic interferences
- Nudging: System to facilitate people flow with doors closing warning signal
- Autotest: Periodic diagnostics to ascertain correct operation of internal systems
- Buzzer: Warning audible signal with option to select the mode: Disabled or Enabled
- Estrema semplicità di installazione
- Ampia capacità di allineamento fra TX e RX
- Adatta per funzionamento statico o dinamico
- Altissima immunità a disturbi elettromagnetici e luminosi
- Nudging: Sistema per agevolazione del flusso delle persone con segnale di avvertimento chiusura porte
- Autotest: Diagnostica periodica per la verifica del corretto funzionamento dei sistemi interni
- Segnalazione acustica di avvertimento con possibilità di selezione della modalità: Esclusa o Attiva

### AVAILABLE MODELS MODELLI DISPONIBILI

Product Prodotto	Diodes q.ty N° diodi	Beams q.ty N° raggi	Operating range Portata	Light curtain height Altezza barriera	Protected height Area protetta	Power supply Alimentazione	Output Uscita	Nudging Door		
GBLEL174E-01	36	174	0 - 3,5 mt. *optional 0 - 6 mt.	2000 mm	da 20 a 1630 mm	220 V AC	Relè Relay	No		
GBLEL174E-02						11-35 V DC 10-30 V AC				
GBLEL174E-03						19-35 V DC 18-30 V AC				
GBLEL194E-01	40	194			*optional 0 - 6 mt.	2000 mm	da 20 a 1830 mm	220 V AC	Relè Relay	Sì Yes
GBLEL194E-02								11-35 V DC 10-30 V AC		
GBLEL194E-01N								220 V AC		
GBLEL194E-02N								11-35 V DC 10-30 V AC		
GBLEL194E-03N								19-35 V DC 18-30 V AC		
GBLEL194T-NC								24 V DC		Transistor
GBLEL194T-PC										



# Light curtains PL Series

Light curtains for elevators and elevating platforms



## Barriere ottiche Serie PL

Barriere ottiche multiraggio per ascensori e piattaforme elevatrici

Light curtains  
Barriere ottiche

Light curtains accessories  
Accessori per barriere

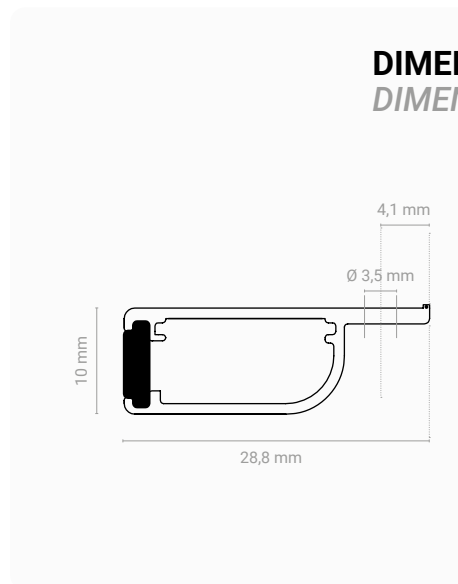

**DIMENSIONI**  
DIMENSIONS



**IP44**

- Extremely easy to install
- Very easy alignment between TX and RX
- Suitable for static and dynamic installation
- High immunity against light and electromagnetic interferences
- Light curtain supplied with relay output control unit
- Buzzer: arning audible signal with option to select the mode: Disabled or Enabled

- Estrema semplicità di installazione
- Ampia capacità di allineamento fra TX e RX
- Adatta per funzionamento statico o dinamico
- Altissima immunità a disturbi elettromagnetici e luminosi
- La barriera viene fornita con alimentatore esterno con uscita a relè
- Segnalazione acustica dei avvertimento con possibilità di selezione della modalità: Esclusa o Attiva

### AVAILABLE MODELS MODELLI DISPONIBILI

**EN81-20**

Product Prodotto	Diodes q.ty N° diodi	Beams q.ty N° raggi	Operating range Portata	Light curtain height Altezza barriera	Protected height Area protetta	Power supply Alimentazione	Output Uscita	Nudging Door
GBLPL174E-01						220V AC		
GBLPL174E-02	36	174	0 - 3,5 mt.	2000 mm	da 20 a 1630 mm	11 - 35V DC 10 - 30V AC	Relè Relay	No
GBLPL174E-03						19 - 35V DC 18 - 30V AC		

**EN81-70**

Product Prodotto	Diodes q.ty N° diodi	Beams q.ty N° raggi	Operating range Portata	Light curtain height Altezza barriera	Protected height Area protetta	Power supply Alimentazione	Output Uscita	Nudging Door
GBLPL096E-01						220V AC		
GBLPL096E-02	17	96	0 - 3,5 mt.	2000 mm	da 20 a 1810 mm	11 - 35V DC 10 - 30V AC	Relè Relay	No
GBLPL096E-03						19 - 35V DC 18 - 30V AC		



# Light curtains SL Series

Light curtains for elevators EN81-20



## Barriere ottiche Serie SL

Barriere ottiche multiraggio per ascensori EN81-20

Light curtains  
Barriere ottiche

Light curtains accessories  
Accessori per barriere

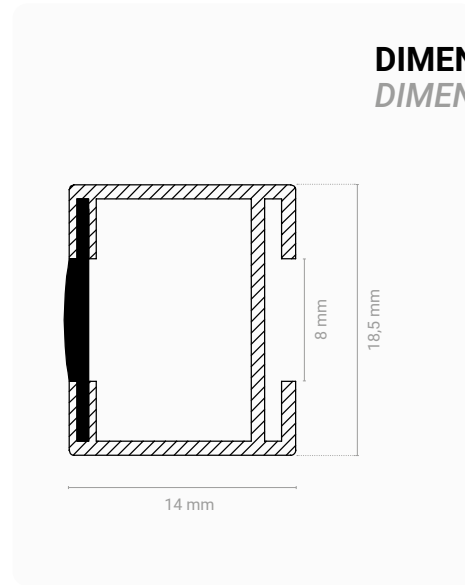

**DIMENSIONI**  
DIMENSIONS



- Extremely easy to install in new or existing lifts
- Very easy alignment between TX and RX
- Suitable for static and dynamic installations
- High immunity against light and electromagnetic interferences
- Nudging: System to facilitate people flow with doors closing warning signal
- Autotest: Periodic diagnostics to ascertain correct operation of internal systems
- Buzzer: Warning audible signal with option to select the mode: Disabled or Enabled

- Estrema semplicità di installazione
- Ampia capacità di allineamento fra TX e RX
- Adatta per funzionamento statico o dinamico
- Altissima immunità a disturbi elettromagnetici e luminosi
- Nudging: Sistema per agevolazione del flusso delle persone con segnale di avvertimento chiusura porte
- Autotest: Diagnostica periodica per la verifica del corretto funzionamento dei sistemi interni
- Segnalazione acustica di avvertimento con possibilità di selezione della modalità: Esclusa o Attiva

### AVAILABLE MODELS MODELLI DISPONIBILI

Product Prodotto	Diodes q.ty N° diodi	Beams q.ty N° raggi	Operating range Portata	Light curtain height Altezza barriera	Protected height Area protetta	Power supply Alimentazione	Output Uscita	Nudging Door
GBLSL194E-01	40	194	0 - 3,5 mt.	2000 mm	da 20 a 1830 mm	220V AC	Relè Relay	Si Yes
GBLSL194E-02						11 - 35V DC 10 - 30V AC		

Versione con regolazione della sensibilità opzionale    Optionale version with sensitivity adjustment



# Light curtains accessories

Vertical fixing bracket for light curtains

## Accessori per barriere

Staffe di fissaggio verticali per barriere



### STATIC INSTALLATION OF OPTICAL BARRIERS

In static installation it is necessary to support the barriers with special brackets. In existing lifts there are frequent difficulties given by having to adapt to confined spaces and existing mechanics (in particular to the door operator).

Giovenzana International B.V. pays particular attention to the fixing of the barriers and wants to offer products for every specific need in the installation.

### INSTALLAZIONE STATICA DELLE BARRIERE OTTICHE

Nell'installazione statica è necessario supportare le barriere con apposite staffature. In ascensori esistenti si presentano frequenti difficoltà date dal doversi adattare a spazi ristretti e a meccaniche esistenti (in particolare all'operatore porta).

Giovenzana International B.V. ha un'attenzione particolare al fissaggio delle barriere e vuole offrire prodotti per ogni specifica esigenza nell'installazione.

### Combinations light curtains, vertical brackets and fixing brackets

*Abbinamenti barriere ottiche, staffe verticali e staffe di fissaggio*

Light Curtains <i>Barriere Ottiche</i>	Vertical bracket <i>Staffa verticale</i>	Door operator bracket <i>Staffa operatore porta</i>	Threshold bracket <i>Staffa soglia</i>
CL Series / Serie CL EL Series / Serie EL	GBLK-SQ2	GBLK-AN2	GBLK-ST2 GBLK-ST3
EL Series / Serie EL	GBLK-SQ3	GBLK-AN2	GBLK-ST2 GBLK-ST3 GBLK-ST4 GBLK-ST5 GBLK-ST6
	GBLK-SQ4 GBLK-SQ5	GBLK-AN5 GBLK-AN6	
CT Series / Serie CT	-	GBLK-AN7 GBLK-AN8	GBLK-ST4 GBLK-ST5 GBLK-ST6 GBLK-ST7
		GBLK-AN9	

# Light curtains accessories

Vertical fixing bracket for light curtains

## Accessori per barriere

Staffe di fissaggio verticali per barriere



Suitable for light curtains  
CL and EL Series

*Idonea per barriere  
Serie CL e EL*

GBLK-AN2

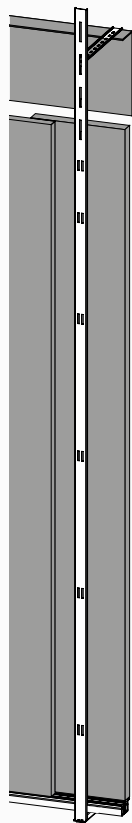

**GBLK-SQ2**

lunghezza  
length  
2500 mm

**GBLK-ST2**  
**GBLK-ST3**

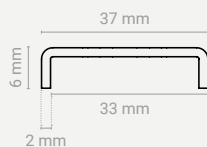

Suitable for light curtains  
EL Series

*Idonea per barriere  
Serie EL*

GBLK-AN2

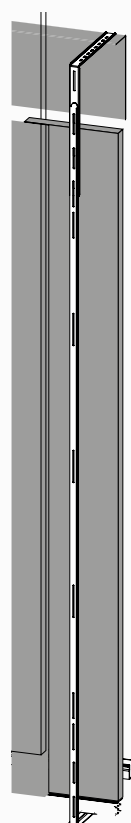

**GBLK-SQ3**

lunghezza  
length  
2200 mm

**GBLK-ST2**  
**GBLK-ST3**



Suitable for light curtains  
EL Series

*Idonea per barriere  
Serie EL*

GBLK-BS1  
GBLK-BS2

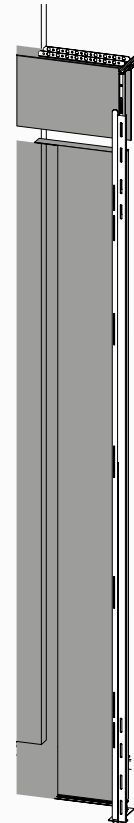

**GBLK-AN7**  
**GBLK-AN8**

**GBLK-SQ4**

lunghezza  
length  
2200 mm

**GBLK-SQ5**

lunghezza  
length  
2500 mm

**GBLK-ST2**  
**GBLK-ST3**  
**GBLK-ST4**  
**GBLK-ST5**  
**GBLK-ST6**

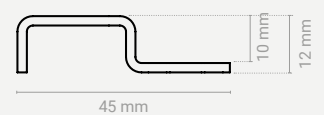



# Light curtains accessories

Fixing bracket for door operator

## Accessori per barriere

Staffe di fissaggio per operatore porta

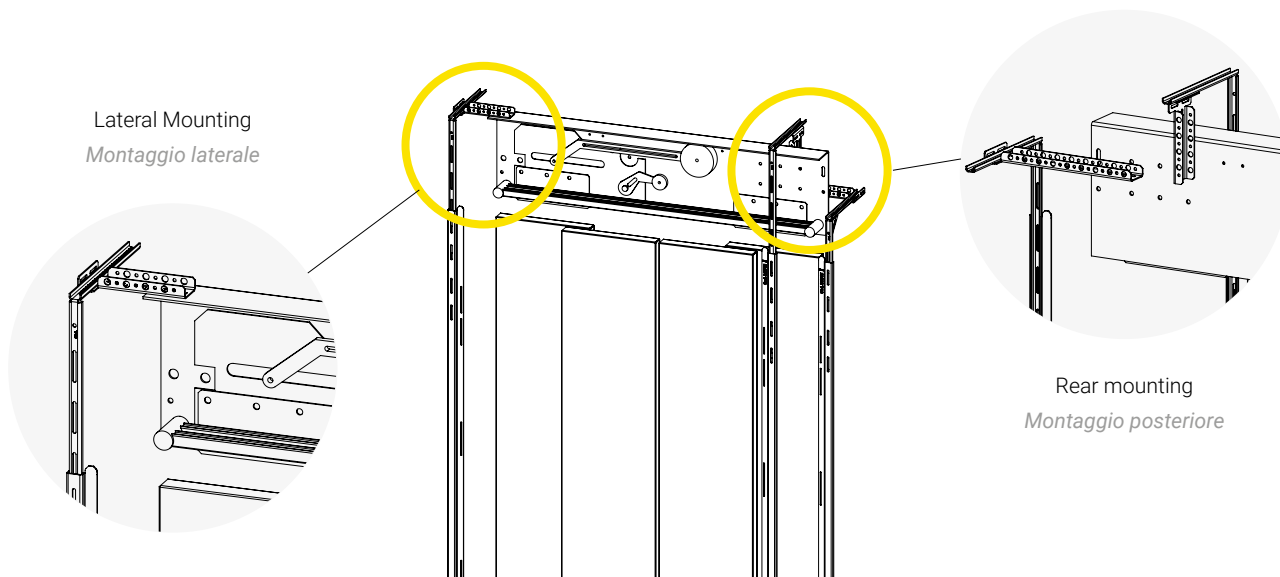

### TRAPEZOIDAL FIXING BRACKET

- Possibility of fixing on most existing door operators
- Suitable for lateral or rear fixing
- Extreme simplicity of installation

### STAFFA DI FISSAGGIO TRAPEZOIDALE

- Possibilità di fissaggio sulla maggior parte degli operatori porta esistenti
- Adatta per fissaggio laterale o posteriore
- Estrema semplicità di installazione

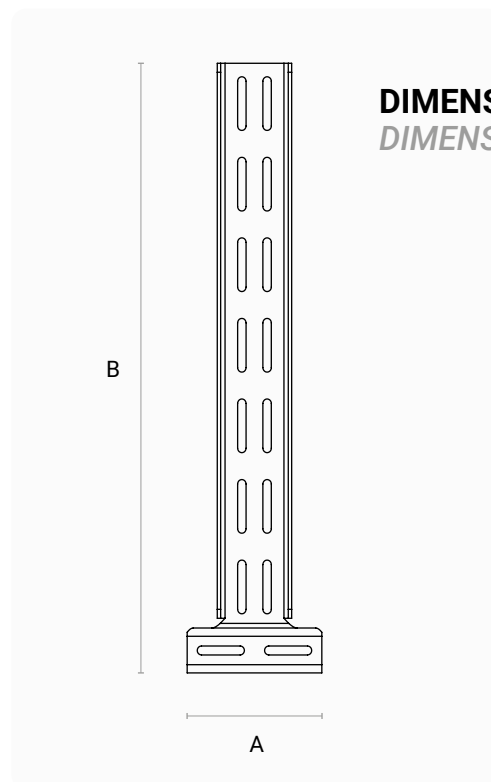

**DIMENSIONS**  
*DIMENSIONI*

Product <i>Prodotto</i>	A	B
<b>GBLK-BS1</b>	80 mm	150 mm
<b>GBLK-BS2</b>		300 mm

## Light curtains accessories

Fixing bracket for door operator

## Accessori per barriere

Staffe di fissaggio per operatore porta

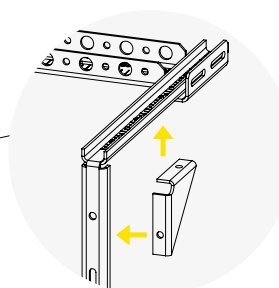
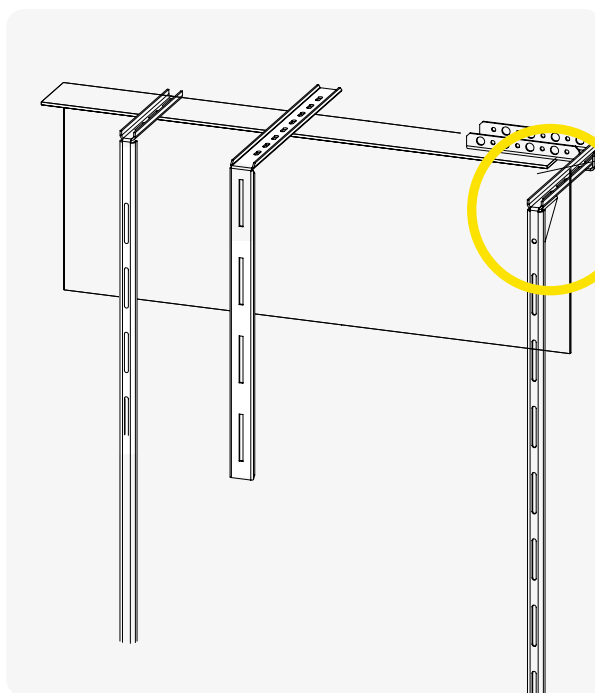

GBLK-R1

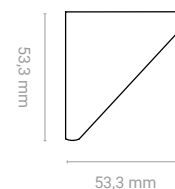

### Corner reinforcement bracket

- Accessory designed to guarantee greater rigidity of the bracket angle and consequently less vibrations to the detriment of the light curtain

### Staffa di rinforzo angolare

- Accessorio studiato per garantire una maggiore rigidità della staffa angolare e di conseguenza minori vibrazioni a discapito della barriera

GBLK-AN2

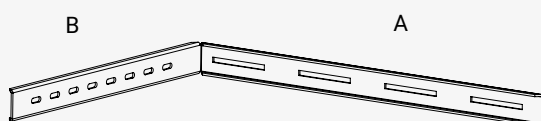

- Angular bracket for direct fixing on the door operator  
- Staffa angolare per fissaggio diretto su operatore porte

Product Prodotto	A	B
GBLK-AN2	--	--

GBLK-AN5  
GBLK-AN6

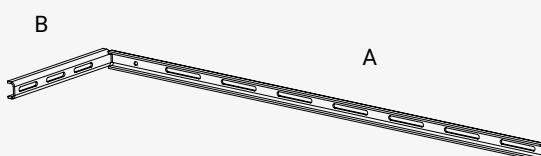

- Angular bracket for direct fixing on the door operator  
- Staffa angolare per fissaggio diretto su operatore porte

Product Prodotto	A	B
GBLK-AN5	624 mm	246 mm
GBLK-AN6		160 mm

# Light curtains accessories

Fixing bracket for cabin threshold

## Accessori per barriera

Staffe di fissaggio per soglia cabina



GBLK-ST2

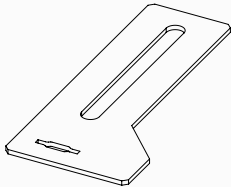

**DIMENSIONS**

*DIMENSIONI*

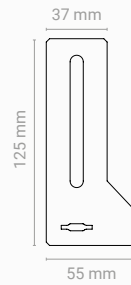

GBLK-ST3

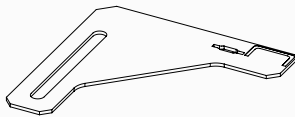

**DIMENSIONS**

*DIMENSIONI*

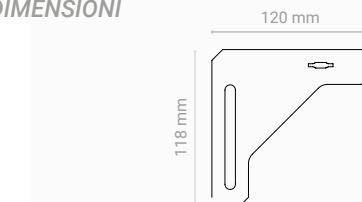

GBLK-ST4

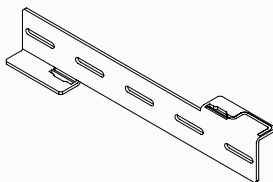

**DIMENSIONS**

*DIMENSIONI*

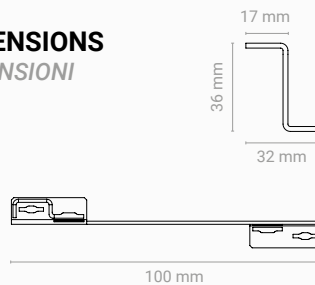

- Fixing bracket to threshold cover
- Staffa di fissaggio al copri soglia

GBLK-ST5

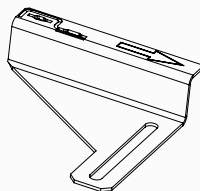

**DIMENSIONS**

*DIMENSIONI*

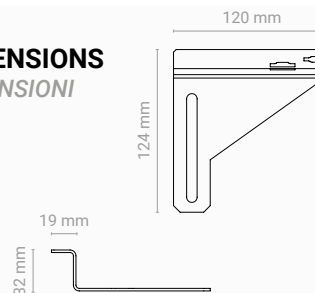

GBLK-ST6

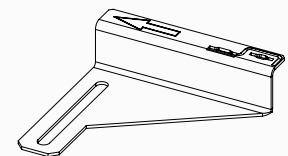

GBLK-ST7

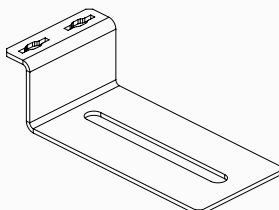

**DIMENSIONS**

*DIMENSIONI*

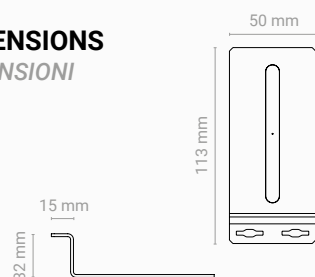



# Light curtains accessories

## Accessori per barriere



Light curtains  
Barriere ottiche

### Galvanically isolated emergency power supply AL-1

#### Alimentatori galvanicamente isolati per barriere AL-1

- For infrared light curtains CL/CLP/CT Series
- Power supply 220V AC
- Output: relay 10A 250V AC
- Per barriere a infrarossi Serie CL/CLP/CT
- Alimentazione 220V AC
- Uscita: relè 10A 250V AC



#### DIMENSIONS DIMENSIONI

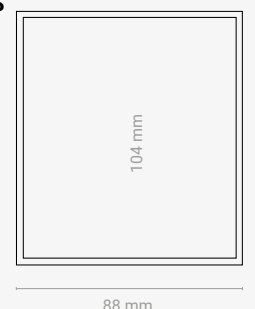

Light curtains accessories  
Accessori per barriere

### Galvanically isolated emergency power supply P

#### Alimentatori galvanicamente isolati per barriere P



#### DIMENSIONS DIMENSIONI

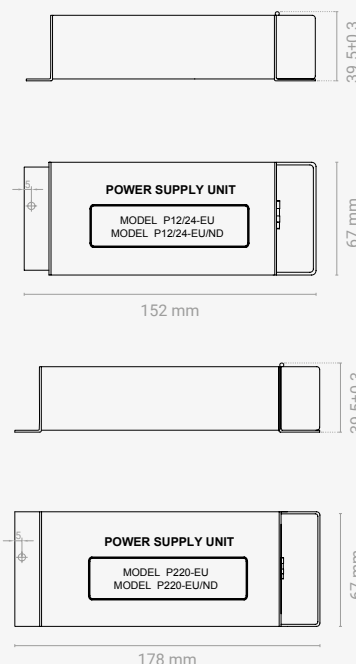

- For infrared light curtains EL/PL/SL Series
- Per barriere a infrarossi Serie EL/PL/SL

Product Prodotto	Power supply Alimentazione	Output Uscita	Nudging Door
GBLP12/24-EU	11-35 V DC 10 - 30 V AC	Relè Relay	No
GBLP12/24-EU/ND			SI Yes
GBLP220-EU	220 V AC	2A 30V DC 1A 125V AC	No
GBLP220-EU/ND			SI Yes

### Cables for light curtains EL/PL/SL Series

#### Cavi per barriere Serie EL/PL/SL

- Replacement 3,5 m cables for infrared light curtains EL/PL/SL Series
- Cavi di ricambio 3,5 m per Barriere a infrarossi Serie EL/PL/SL







**GIOVENZANA**  
INTERNATIONAL B.V.

**GIOVENZANA INTERNATIONAL B.V.**

Strawinskylaan 1427, 1077 XX Amsterdam, The Netherlands

Ph. +31(0)20.4413576 | Fax +31(0)20.4413456

[giovenzana@giovenzana.com](mailto:giovenzana@giovenzana.com)

[www.giovenzana.com](http://www.giovenzana.com)