

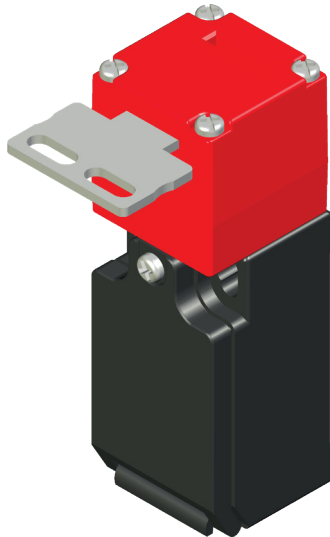

STNK02...



THERMOPLASTIC SAFETY SWITCH WITH SEPARATE ANGLED ACTUATOR

Thermoplastic safety switch with separate actuator
Vertical or horizontal action
Stainless steel straight actuator
Electrically independent contacts (Zb)
Enclosure degree of protection: IP65
Compliance: EN 50047, IEC/EN 60947-5-1, UL 508, up to SIL3
Marking: CE, CCC, UL, EAC, UKCA



Series

STNK thermoplastic safety switches with separate actuator



Function

02 straight actuator

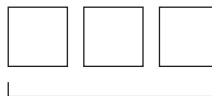

Contact type

X11 1NO/1NC slow action Zb
W02 2NC slow action Zb
Z11 1NO/1NC snap action Zb
Z02 2NC snap action Zb
W12 1NO/2NC slow action Zb
W03 3NC slow action Zb

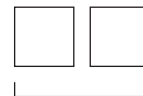

Lead exit dimension or type

blank M16 (standard)
M M20
N 1/2NPT
G1 PG11
G3 PG13.5
C male code "A" M12x1 connector



Positive opening operation		NC contact ⊕
Minimum current		5 mA - 5 V DC
Thermal current	I _{th}	10 A
Rated insulation voltage	U _i	500 V
Rated impulse withstand voltage	U _{imp}	6 kV
Insulation resistance	min	100 MΩ (DC 500 V)
Contact resistance	max	25 mΩ (initial)
Actuator switching frequency	max	2 cycles/min
Enclosure material		glass filled PBT (UL approved)
Enclosure degree of protection		IP65
Operating temperature		-25 ... +80°C (-18 ... +176°F)
Pollution degree		3
Protection against electric shock		class II (double insulation) ▢
Mechanical life expectancy	min	1×10 ⁶ cycles
Electrical life expectancy	min	150000 cycles
Vibration	IEC 68-2-6	10-55 ±1 Hz
	excursion	0.35 mm, 1 octave/min
Fixing		2 × M4 screws

STNK02...

Contact types	Categories *	Ratings **	PT1	PT2 / RP	OF	POT ⊖	POF	TT
X11 1NO 1NC	slow action (Zb) A600 - Q600	AC15: 400 V - 4 A	7.4 mm	8.4 mm	25 N	8.1 mm	60 N	∞
W02 2NC			7.4 mm	-	25 N	8.1 mm	60 N	
Z11 1NO 1NC	snap action (Zb) B600 - Q600	DC13: 24 V - 6 A	6.5 mm	4.8 mm	14 N	8.0 mm	26 N	∞
Z02 2NC			6.5 mm	4.5 mm	14 N	8.0 mm	26 N	
W12 1NO 2NC	slow action (Zb) A300 - Q300		7.2 mm	8.0 mm	25 N	8.2 mm	60 N	
W03 3NC			7.2 mm	-	25 N	8.2 mm	60 N	

* UL 508 / CSA C22-2 n° 14 ** IEC/EN 60947-1

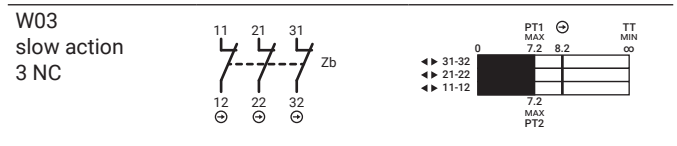
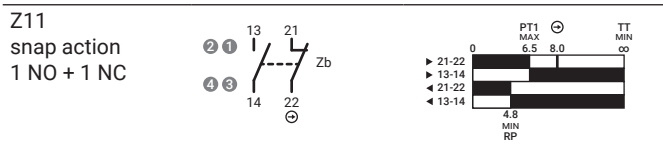
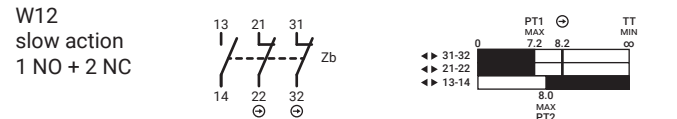
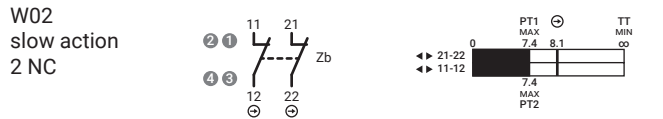
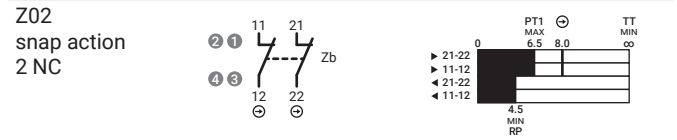
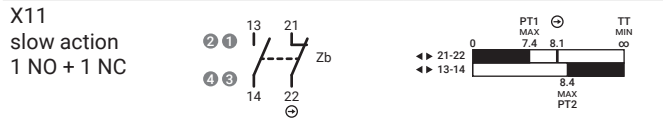

- PT1 Operating travel
- PT2 Second operating travel (slow action)
- RP Release position (snap action)
- OF Operating force
- POT Positive opening travel ⊖
- POF Positive opening force
- TT Total travel



M12 Connector pin arrangement - on request

(1) Mounting holes

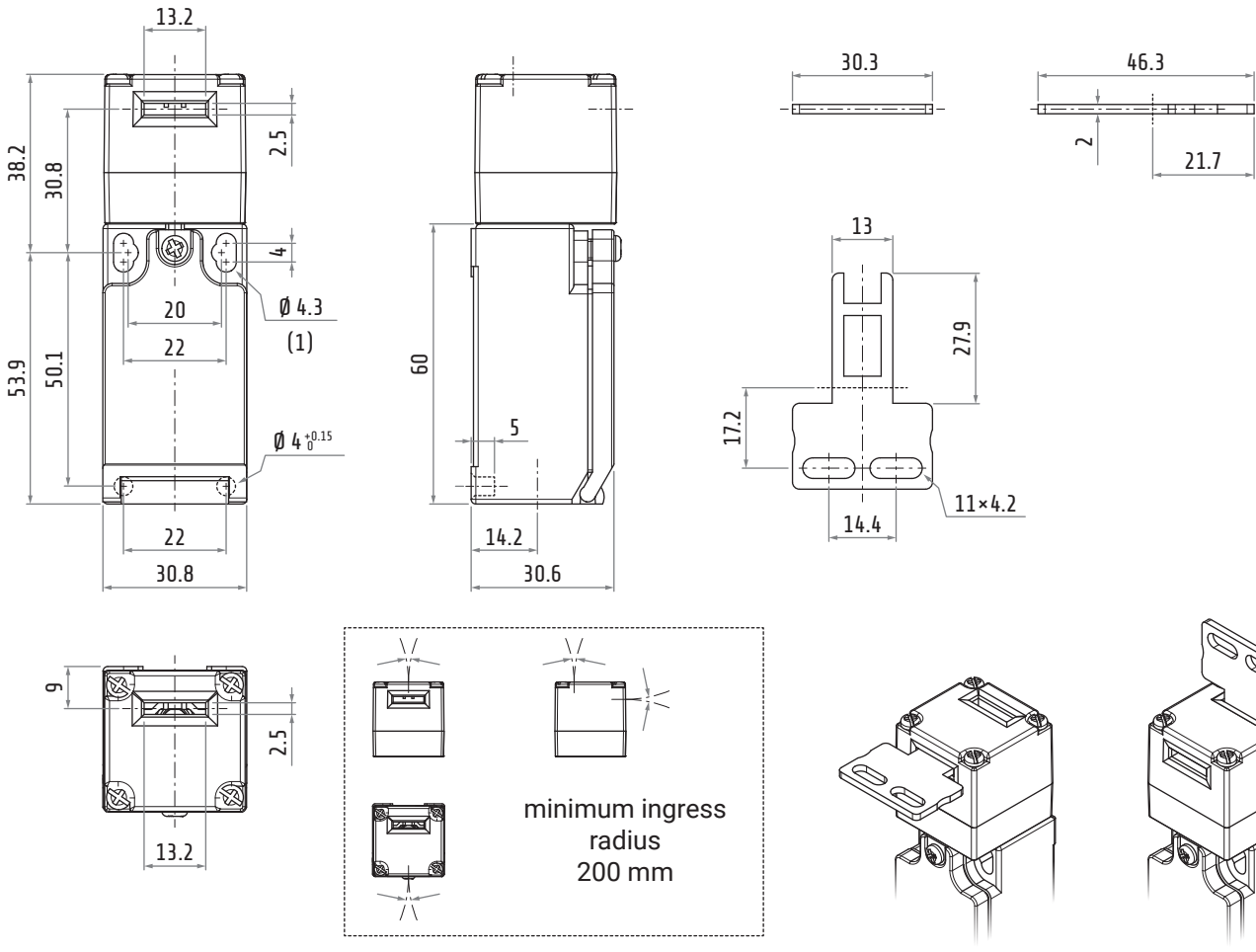

Dimensions in mm / illustrations NOT in scale