

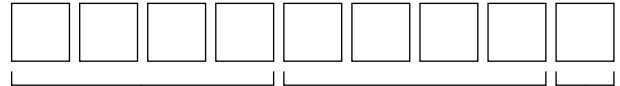

P012... / P016... / P020... PX12... / PX16... / PX20...

CAM SWITCHES SIZES: 12 A / 16 A / 20 A

Code reading



Cam switch
electrical scheme
(see p.9)

Cam switch series
(this datasheet)

Cam switch mounting type

Code example

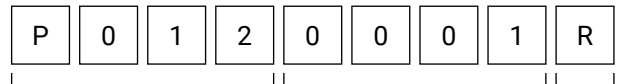



Cam switch series

Cam switch electrical scheme

Cam switch mounting type

SEE AVAILABLE ACTUATORS ON p.16

	P012... P016... P020...	PX12... PX16... PX20...
Specifications	p.2	p.2
Terminal protection class	 IP20	 IP10

R Rear panel mounting	 p.5	 p.6
------------------------------------	--	--

B Base mounting DIN rail mounting	 p.7	-
--	--	---

D DIN mounting 46 mm with actuator (equipped with typical actuator p.n. 027/...)	 p.8	-
---	--	---

SPECIFICATIONS

General characteristics

Protection class	control	EN 60529 UL50 / NEMA	IP65 Type 1 - 4 - 4X
	control with knob only		IP40
	terminals		P012... / P016... / P020... PX12... / PX16... / PX20... IP20 IP10
Material group		EN 60947-1	II
Pollution grade		EN 60947-1	3
Flammability		UL94	V0 (live electrical parts)
Ambient temperature	operating		-40 ... +85°C
	storage		-40 ... +70°C
Climate withstand		IEC 68 part 2-3 IEC 68 part 2-30	damp heat, steady state damp heat, cyclic
Terminal screw identification	conforming to		EN50013
Connections	terminal block caliber	EN60947-1	A3
	terminal screw		M3.5
	tightening torque	EN60947-1 UL508	0.8 N·m (7.2 lb·in) 7.5 lb·in (0.85 N·m)
Connectable section	flexible conductors		1 × 0.75 ... 4 mm ² or 2 × 0.75 ... 2.5 mm ² AWG 18 ... 10
	solid conductors		1 × 0.75 ... 4 mm ² or 2 × 0.75 ... 2.5 mm ² AWG 18 ... 10
Contacts			double breaking
Opening angles			30° - 45° - 60° - 90°
Mechanical lifetime	@ 120 operations / hour		1 million cycles
Electrical lifetime	@ 120 operations / hour		P012... / PX12... 1 million cycles P016... / PX16... 0.75 million cycles P020... / PX20... 0.75 million cycles

EN 60947-3 characteristics

		P012... / PX12...	P016... / PX16...	P020... / PX20...
Rated operating voltage	U _e	690 V	690 V	690 V
Rated insulation voltage	U _i	690 V	690 V	690 V
Rated impulse withstand voltage (sectionable)	U _{imp}	4 kV	4 kV	4 kV
Rated thermal current	I _{th}	16 A	20 A	25 A
Rated enclosed thermal current	I _{the}	12 A	16 A	20 A
Frequency		50/60 Hz	50/60 Hz	50/60 Hz

Alternate current

Rated operating current		le		P012... / PX12...	P016... / PX16...	P020... / PX20...			
AC-21A	Switching of resistive loads, including moderate overloads		690 V	12 A	16 A	20 A			
AC-22A	Switching of mixed resistive and inductive loads, including moderate overloads		690 V	12 A	16 A	20 A			
AC-23A	Switching of motor loads or other highly inductive loads	1 phase - 1 pole	110 V	12 A	1.1 kW	14 A	1.5 kW	18 A	2 kW
			230 V	12 A	2.2 kW	14 A	3 kW	18 A	4 kW
		3 phases - 3 poles	230 V	10 A	3 kW	14 A	3 kW	16 A	5 kW
			400 V	10 A	5.5 kW	14 A	7.5 kW	16 A	9 kW
			500 V	10 A	7.5 kW	14 A	10 kW	16 A	11 kW
690 V	10 A	7.5 kW	14 A	10 kW	16 A	12.5 kW			
AC-3	Squirrel-cage motors: starting, switches off motors during running time	1 phase - 1 pole	110 V	10 A	0.75 kW	12 A	1.1 kW	16 A	1.5 kW
			230 V	10 A	2 kW	12 A	2.2 kW	16 A	3.5 kW
		3 phases - 3 poles	230 V	8 A	2.2 kW	10 A	3 kW	12 A	4 kW
			400 V	8 A	4 kW	10 A	5 kW	12 A	6 kW
			500 V	8 A	5.5 kW	10 A	7.5 kW	12 A	8 kW
690 V	6 A	5.5 kW	8 A	7.5 kW	10 A	9 kW			
AC-23A	Nominal breaking capacity (cosφ 0.45)		230 V	80 A	104 A	128 A			
			400 V	80 A	104 A	128 A			
			500 V	80 A	112 A	128 A			
			690 V	80 A	112 A	128 A			
Power dissipation for each pole				0.3 W	0.35 W	0.4 W			

Direct current

Rated operating current		le		P012... / PX12...	P016... / PX16...	P020... / PX20...
DC-21A	Switching resistive loads with light overloads	1 phase	50 V	10 A	12 A	16 A
DC-22A	Switching resistive loads with light overloads	1 phase	30 V	8 A	10 A	12 A

Short circuit characteristics

		P012... / PX12...	P016... / PX16...	P020... / PX20...
Rated short-time short circuit withstand current (1 s)	l _{cw}	300 A	300 A	300 A
Rated short circuit making capacity	l _{cm}	1200 A	1200 A	1200 A
Conditional rated short circuit withstand current		5 kA	5 kA	5 kA
Fuse rating (type gG)	690 V	20 A	20 A	20 A

UL 508 characteristics

		P012... / PX12...		P016... / PX16...		P020... / PX20...	
General use	600 V AC	12 A		16 A		20 A	
Standard motor load	1 phase - 2 poles	120 V AC	0.5 HP 9.8 FLA	1 HP 16 FLA	1.5 HP 20 FLA	1.5 HP 20 FLA	2 HP 12 FLA
		240 V AC	1 HP 8 FLA	1.5 HP 10 FLA	2 HP 12 FLA		
	3 phases - 3 poles	200 V AC	1.5 HP 6.9 FLA	3 HP 11.04 FLA	5 HP 17.5 FLA	5 HP 17.5 FLA	
		240 V AC	3 HP 9.6 FLA	5 HP 15.2 FLA	5 HP 15.2 FLA		
		480 V AC	5 HP 7.6 FLA	7.5 HP 11 FLA	10 HP 14 FLA		
		600 V AC	5 HP 6.1 FLA	7.5 HP 9 FLA	10 HP 11 FLA		

Marking

Compliance by passed test

Approved



OVERALL DIMENSIONS

Rear panel mounting

P012... / P016... / P020...

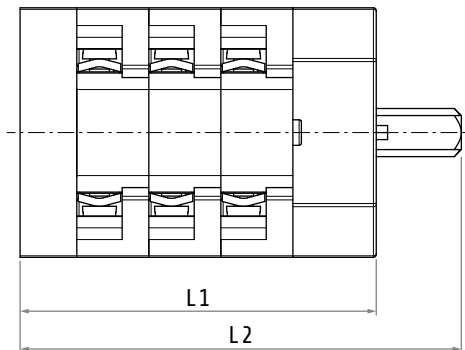
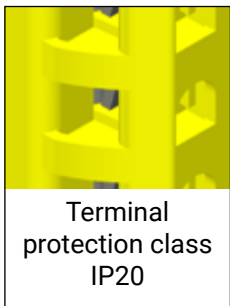
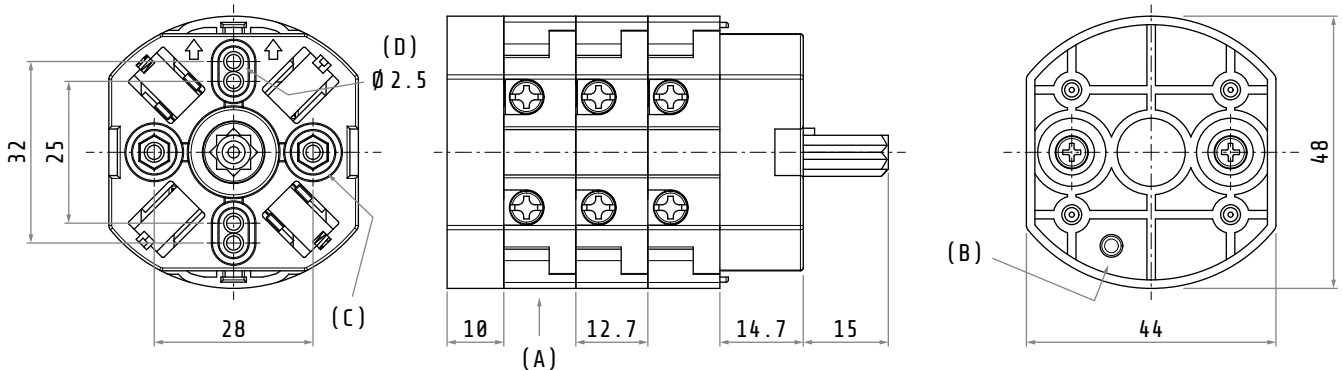

Dimensions in mm
Illustrations NOT in scale

- (A) wafer (thickness = 12.7 mm)
- (B) reference notch
- (C) metric screw (M3) fixing hole
- (D) self tapping screw (Ø 3.2) fixing hole

Some dimensions depend on the number of wafers of the cam switch and can be calculated with these formulas:

$$L1 \text{ [mm]} = 10 + (12.7 \times \text{n. of wafers}) + 14.7$$

$$L2 \text{ [mm]} = L1 + 15$$

Examples:

n. of wafers	1	2	3	4	5	6
L1 [mm]	37.4	50.1	62.8	75.5	88.2	100.9
L2 [mm]	52.4	65.1	77.8	90.5	103.2	115.9

Rear panel mounting

PX12... / PX16... / PX20...

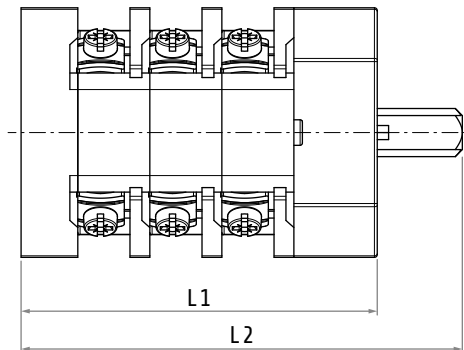
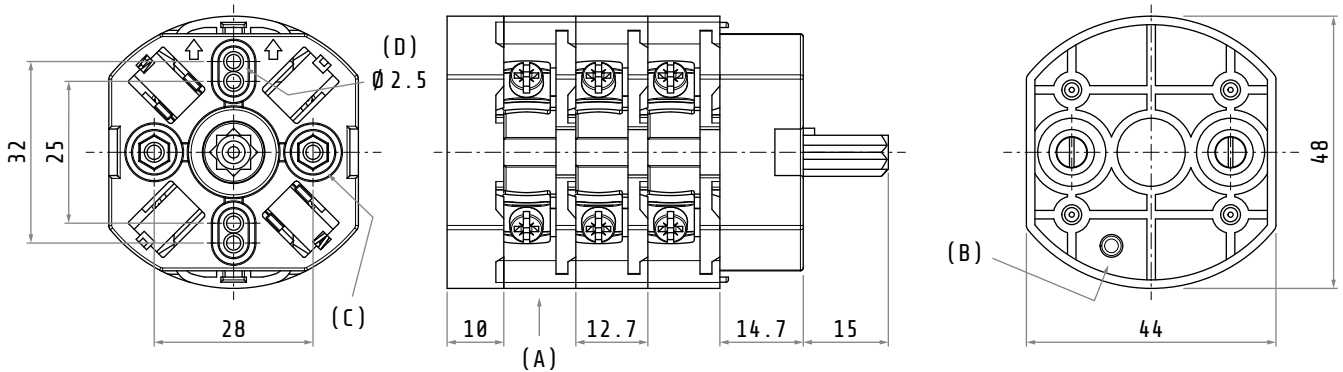

Dimensions in mm
Illustrations NOT in scale

- (A) wafer (thickness = 12.7 mm)
- (B) reference notch
- (C) metric screw (M3) fixing hole
- (D) self tapping screw (Ø 3.2) fixing hole

Some dimensions depend on the number of wafers of the cam switch and can be calculated with these formulas:

$$L1 \text{ [mm]} = 10 + (12.7 \times \text{n. of wafers}) + 14.7$$

$$L2 \text{ [mm]} = L1 + 15$$

Examples:

N. of wafers	1	2	3	4	5	6
L1 [mm]	37.4	50.1	62.8	75.5	88.2	100.9
L2 [mm]	52.4	65.1	77.8	90.5	103.2	115.9

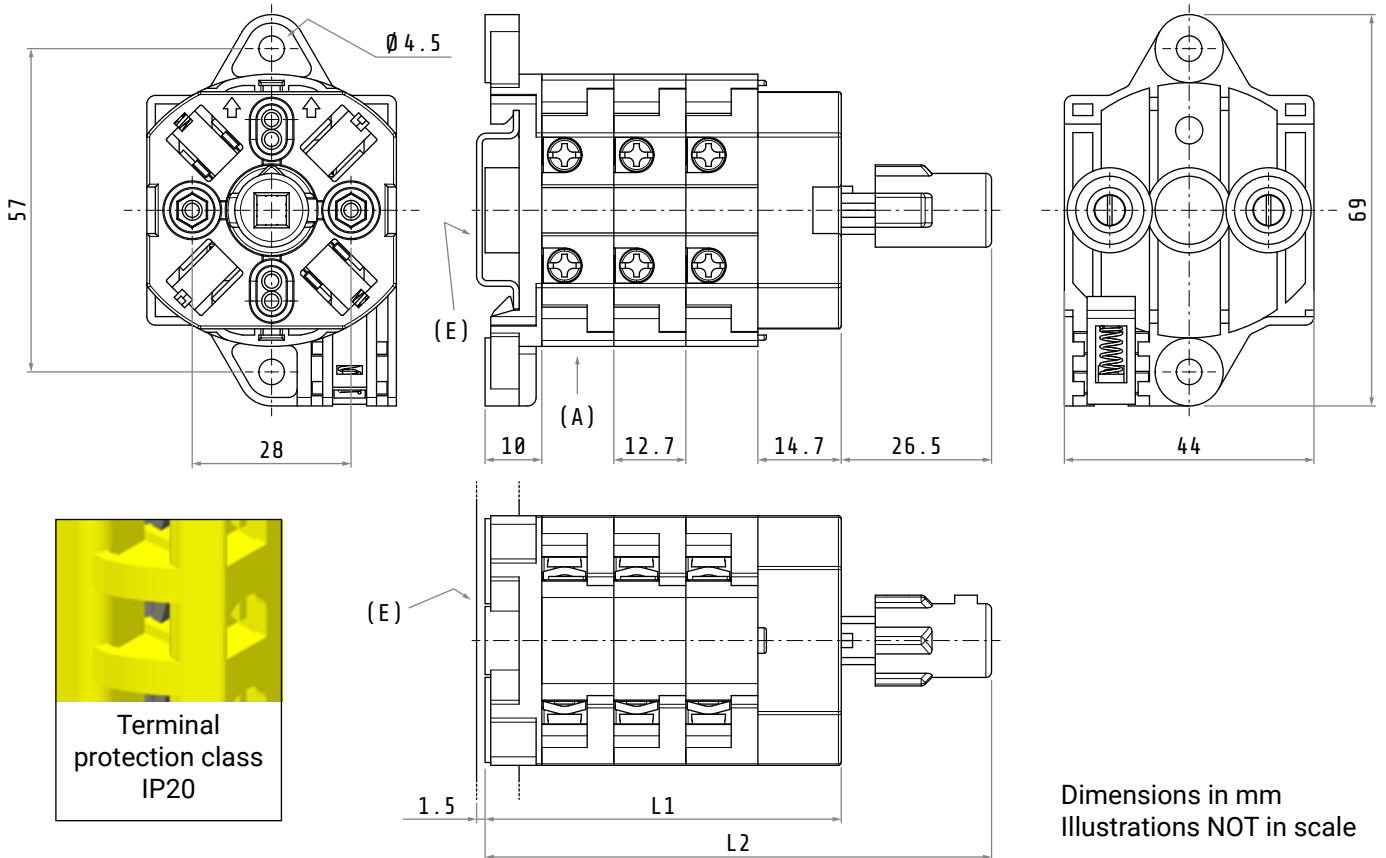

- (A) wafer (thickness = 12.7 mm)
- (E) DIN rail 35 mm (EN 46277/3)

Some dimensions depend on the number of wafers of the cam switch and can be calculated with these formulas:

$$L1 \text{ [mm]} = 10 + (12.7 \times \text{n. of wafers}) + 14.7$$

$$L2 \text{ [mm]} = L1 + 26.5$$

Examples:

N. of wafers	1	2	3	4	5	6
L1 [mm]	37.4	50.1	62.8	75.5	88.2	100.9
L2 [mm]	63.9	76.6	89.3	102	114.7	127.4

Please note

This configuration allows both base mounting and DIN mounting.

DIN mounting \varnothing 46 mm with actuator

P012... / P016... / P020...

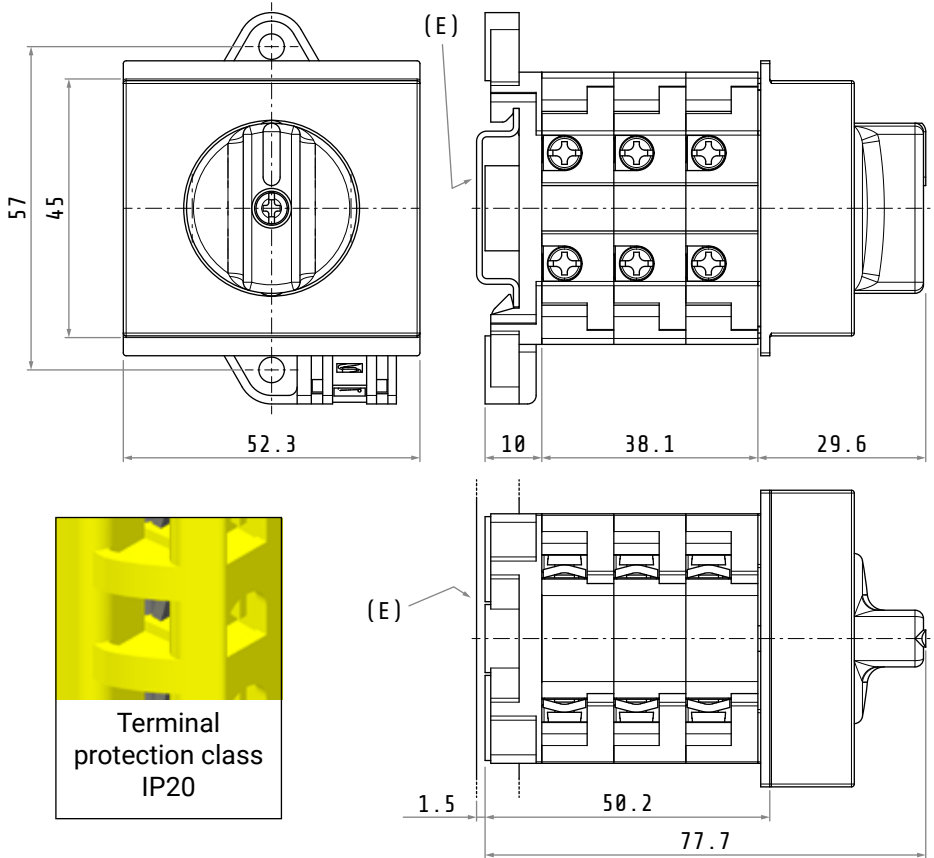

Terminal
protection class
IP20

Dimensions in mm
Illustrations NOT in scale

(E) DIN rail 35 mm (EN 46277/3)

Please note

The standard cam switches for DIN mounting with actuator are built with 3 wafers.

The standard cam switches for DIN mounting with actuator are typically equipped with actuator p.n. 027/.... (separated and to be assembled).

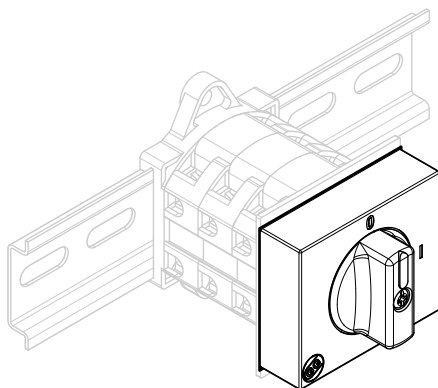

This installation implies DIN rails in 46 mm standard boxes like in the picture on the left.

ELECTRICAL SCHEMES

Code checking pattern

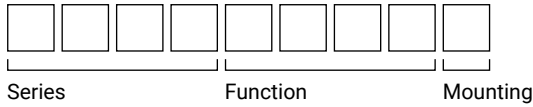

Example: cam switch on catalog

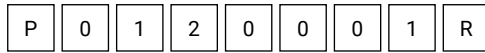

Example: cam switch NOT on catalog

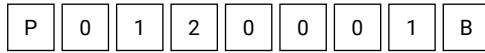

P012 / PX12	P012	P012
P016 / PX16	P016	P016
P020 / PX20	P020	P020

Function	N. of wafers	R	B	D
ON-OFF switches 0-1 p.10				
0001 ON-OFF switch 1 pole	1	x	-	x
0002 ON-OFF switch 2 poles	1	x	x	x
0003 ON-OFF switch 3 poles	2	x	x	x
0004 ON-OFF switch 4 poles	2	x	x	x
0005 ON-OFF switch 5 poles	3	x	-	x
0006 ON-OFF switch 6 poles	3	x	x	x
0007 ON-OFF switch 3 poles with spring return to zero	2	x	-	-
Changeover switches 1-0-2 p.10				
0008 Changeover switch 1 pole	1	x	x	x
0009 Changeover switch 2 poles	2	x	x	x
0010 Changeover switch 3 poles	3	x	x	x
0011 Changeover switch 4 poles	4	x	x	-
Motor switches p.11				
0012 Reversing switch 3 poles	3	x	-	-
0013 Reversing switch 3 poles with spring return to zero	3	x	-	-
0014 Dahlander pole changing two speed switch	4	x	-	-
0015 Star-delta starter switch	4	x	-	-
0016 Reversing switch single phase with centrifugal cut-out	3	x	-	-
0031 Reversing-dahlander pole changing two speed switch	6	x	-	-
0017 Starter switch single phase with auxiliary phase	2	x	-	-
0018 Reversing-starter switch single phase with auxiliary phase	3	x	-	-
Ammeter and voltmeter switches p.12				
0019 Ammeter selector switch 1 pole for 3 current transformers	3	x	-	x
0020 Voltmeter selector switch phase-neutral	2	x	-	x
0021 Voltmeter selector switch phase-phase	2	x	-	x
0022 Voltmeter selector switch phase-phase for two circuits	4	x	-	-
0023 Voltmeter selector switch phase-phase and phase-neutral	3	x	-	x
0024 Voltmeter selector switch phase-phase and 1 phase-neutral	3	x	-	x
Step switches p.13				
0025 Step switch 1-2 positions without zero 1 pole	1	x	-	-
0026 Step switch 1-2 positions without zero 2 poles	2	x	-	-
0027 Step switch 1-2 positions without zero 3 poles	3	x	-	-
0038 Step switch 1-2-3 positions without zero 1 pole	2	x	-	-
0039 Step switch 1-2-3 positions without zero 2 poles	3	x	-	-
0040 Step switch 1-2-3 positions without zero 3 poles	5	x	-	-
0041 Step switch 1-2-3-4 positions without zero 1 pole	2	x	-	-
0042 Step switch 1-2-3-4 positions without zero 2 poles	4	x	-	-
0043 Step switch 1-2-3-4 positions without zero 3 poles	6	x	-	-
0028 Step switch 0-1-2 positions with zero 1 pole	1	x	-	-
0032 Step switch 0-1-2 positions with zero 2 poles	2	x	-	-
0033 Step switch 0-1-2 positions with zero 3 poles	3	x	-	-
0029 Step switch 0-1-2-3 positions with zero 1 pole	2	x	-	-
0034 Step switch 0-1-2-3 positions with zero 2 poles	3	x	-	-
0035 Step switch 0-1-2-3 positions with zero 3 poles	5	x	-	-
0030 Step switch 0-1-2-3-4 positions with zero 1 pole	2	x	-	-
0036 Step switch 0-1-2-3-4 positions with zero 2 poles	4	x	-	-
0037 Step switch 0-1-2-3-4 positions with zero 3 poles	6	x	-	-

ON-OFF switches 0-1

0001 • 1 pole

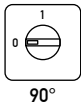

1				
	1-2			x
W	CNT	0		1

0002 • 2 poles



1	3-4			x
	1-2			x
W	CNT	0		1

0003 • 3 poles

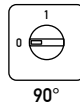

2				
	5-6			x
1	3-4			x
	1-2			x
W	CNT	0		1

0004 • 4 poles

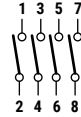
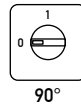

2	7-8			x
	5-6			x
1	3-4			x
	1-2			x
W	CNT	0		1

0005 • 5 poles

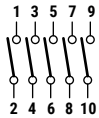
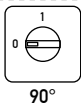

3				
	9-10			x
2	7-8			x
	5-6			x
1	3-4			x
	1-2			x
W	CNT	0		1

0006 • 6 poles

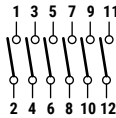
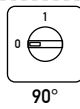

3	11-12			x
	9-10			x
2	7-8			x
	5-6			x
1	3-4			x
	1-2			x
W	CNT	0		1

0007 • 3 poles with spring return to zero

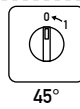

2				
	5-6			x
1	3-4			x
	1-2			x
W	CNT	0		1

Changeover switches 1-0-2

0008 • 1 pole

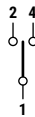
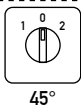

1	3-4			x
	1-2	x		
W	CNT	1	0	2

0009 • 2 poles

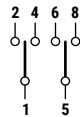
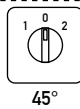

2	7-8			x
	5-6	x		
1	3-4			x
	1-2	x		
W	CNT	1	0	2

0010 • 3 poles

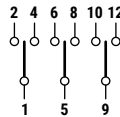
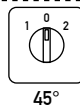

3	11-12			
	9-10	x		
2	7-8			x
	5-6	x		
1	3-4			x
	1-2	x		
W	CNT	1	0	2

0011 • 4 poles

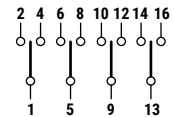
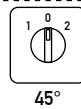

4	15-16			
	13-14	x		
3	11-12			x
	9-10	x		
2	7-8			x
	5-6	x		
1	3-4			x
	1-2	x		
W	CNT	1	0	2

Motor switches

0012 • Reversing switch 3 poles

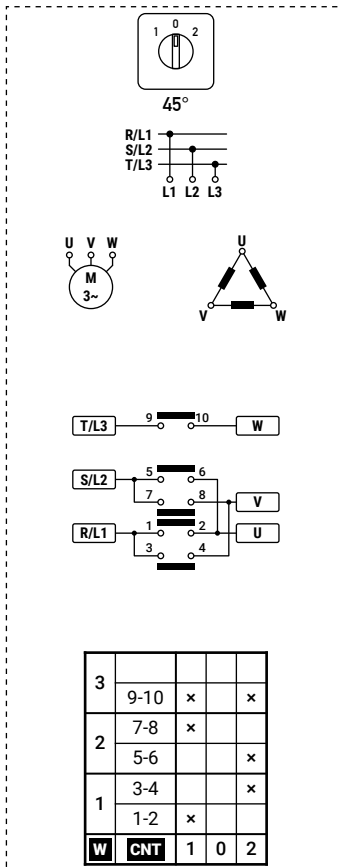

0013 • Reversing switch 3 poles with spring return to zero

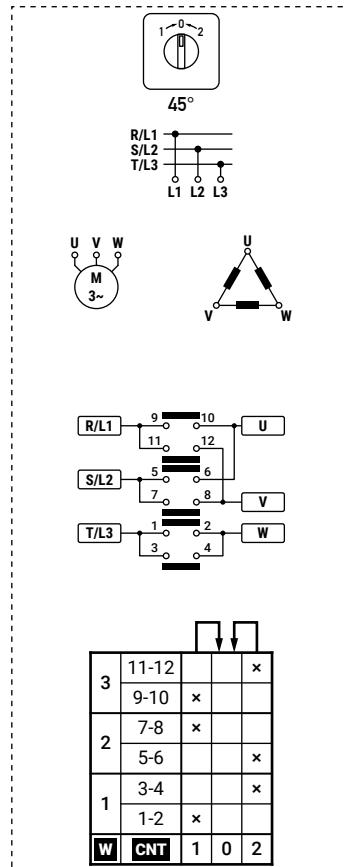

0014 • Dahlander pole changing two speed switch

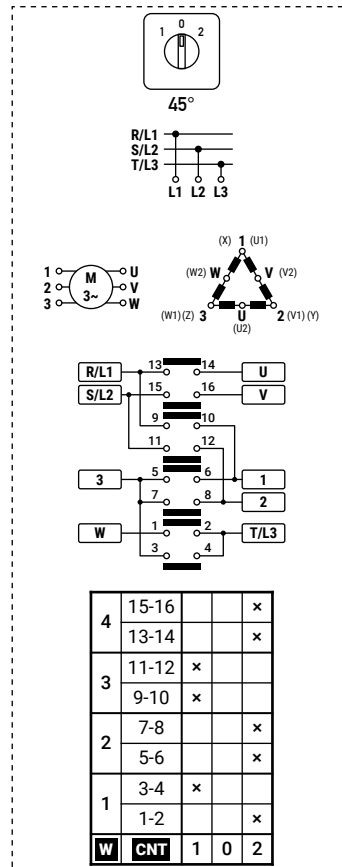

0015 • Star-Delta starter switch

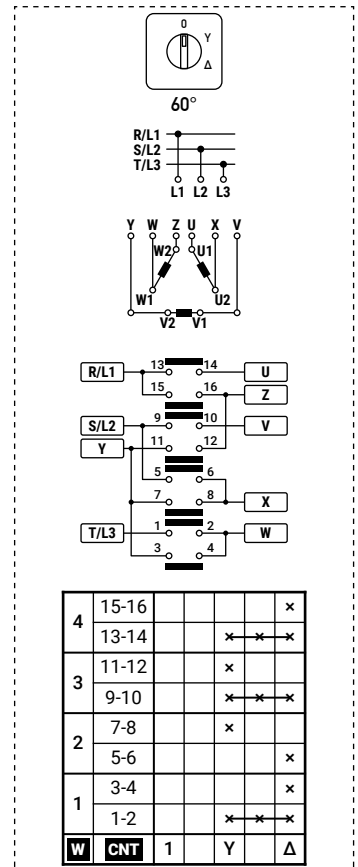

0016 • Reversing switch single phase with centrifugal cut-out

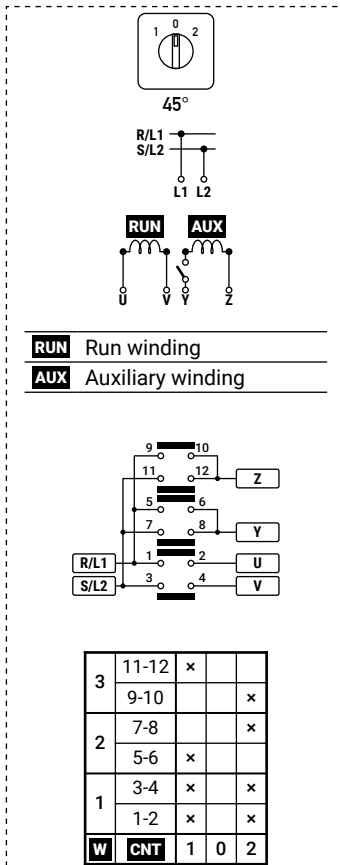

0031 • Reversing-Dahlander pole changing two speed switch

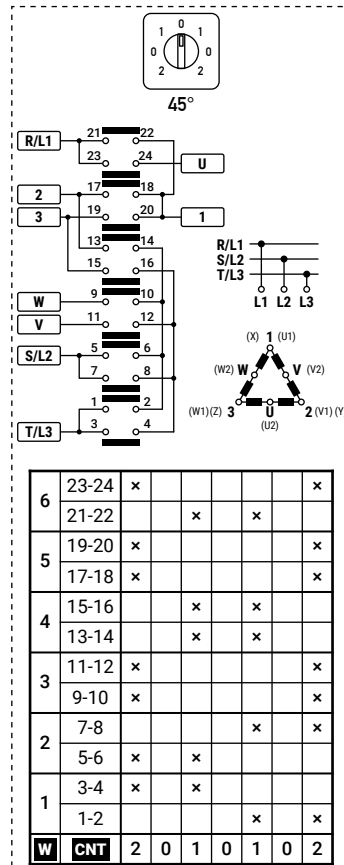

0017 • Starter switch single phase with auxiliary phase

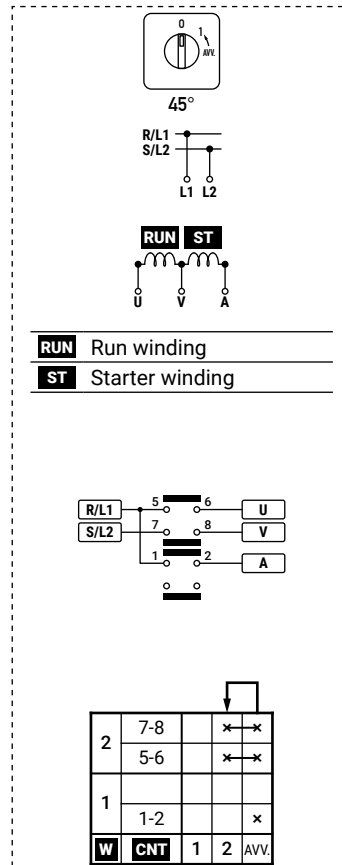

0018 • Reversing-starter switch single phase with auxiliary phase

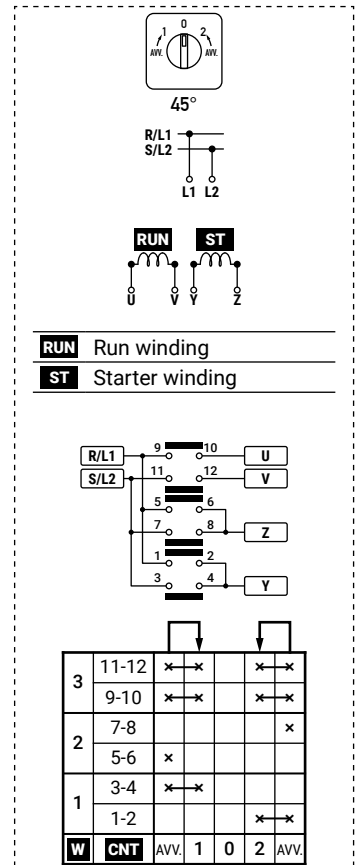

Ammeter and voltmeter switches

1/1

0019 • Ammeter selector switch
1 pole for 3 current transformers

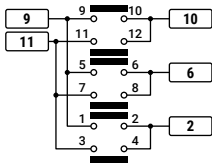
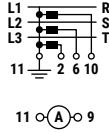
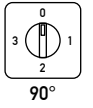

3	11-12	x	x	x	x	x	x
	9-10		x	x	x		
2	7-8	x	x	x		x	x
	5-6			x	x		
1	3-4	x	x	x	x		x
	1-2					x	x
W	CNT	0	1	2	3		

0020 • Voltmeter selector switch phase-neutral

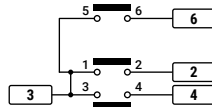
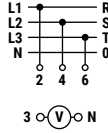
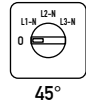

2	5-6				x
	3-4			x	
1	1-2		x		
W	CNT	1	L1-N	L2-N	L3-N

0021 • Voltmeter selector switch phase-phase

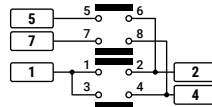
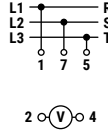
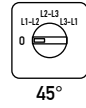

2	7-8	x	x		
	5-6			x	x
1	3-4				x
	1-2		x		
W	CNT	1	L1-L2	L2-L3	L3-L1

0022 • Voltmeter selector switch phase-phase for two circuits

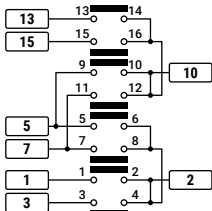
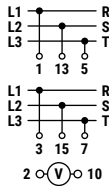
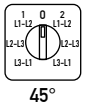

4	15-16		x	x				
	13-14				x	x		
3	11-12	x						
	9-10					x		
2	7-8	x						
	5-6				x			
1	3-4	x	x					
	1-2			x	x			
W	CNT	L3-L1	L2-L3	L1-L2	0	L1-L2	L2-L3	L3-L1
		1	2					

0023 • Voltmeter selector switch phase-phase and phase-neutral

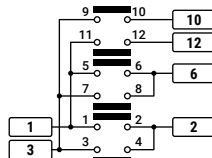
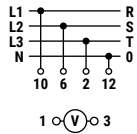
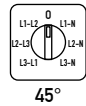

3	11-12				x	x	x	
	9-10	x	x					
2	7-8		x					
	5-6		x			x		
1	3-4	x	x					
	1-2						x	
W	CNT	L3-L1	L2-L3	L1-L2	0	L1-N	L2-N	L3-N

0024 • Voltmeter selector switch phase-phase and 1 phase-neutral

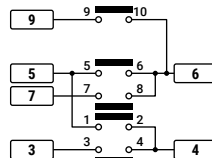
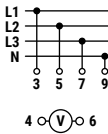
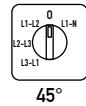

3	9-10					x
	7-8	x	x			
2	5-6		x			
	3-4	x	x			x
1	1-2		x			
W	CNT	L3-L1	L2-L3	L1-L2	0	L1-N

Step switches

1/3

0025 • Step switch 1-2 positions without zero 1 pole

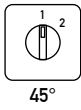

1	3-4		x
	1-2	x	
W	CNT	1	2

0026 • Step switch 1-2 positions without zero 2 poles

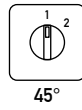

2	7-8		x
	5-6	x	
1	3-4		x
	1-2	x	
W	CNT	1	2

0027 • Step switch 1-2 positions without zero 3 poles

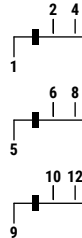
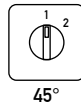

3	11-12		x
	9-10	x	
2	7-8		x
	5-6	x	
1	3-4		x
	1-2	x	
W	CNT	1	2

0038 • Step switch 1-2-3 positions without zero 1 pole

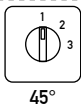

2	5-6			x
1	3-4		x	
	1-2	x		
W	CNT	1	2	3

0039 • Step switch 1-2-3 positions without zero 2 poles

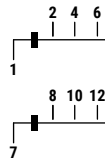
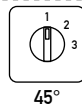

3	11-12			x
	9-10		x	
2	7-8	x		
	5-6			x
1	3-4		x	
	1-2	x		
W	CNT	1	2	3

0040 • Step switch 1-2-3 positions without zero 3 poles

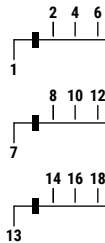
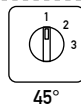

5	17-18			x
4	15-16		x	
	13-14	x		
3	11-12			x
	9-10		x	
2	7-8	x		
	5-6			x
1	3-4		x	
	1-2	x		
W	CNT	1	2	3

Step switches

2/3

0041 • Step switch 1-2-3-4 positions without zero 1 pole

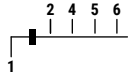
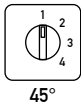

2	7-8			x	
	5-6		x		
1	3-4	x			
	1-2	x			
W	CNT	1	2	3	4

0042 • Step switch 1-2-3-4 positions without zero 2 poles

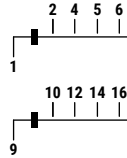
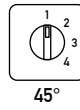

4	15-16			x	
	13-14		x		
3	11-12	x			
	9-10	x			
2	7-8			x	
	5-6		x		
1	3-4	x			
	1-2	x			
W	CNT	1	2	3	4

0043 • Step switch 1-2-3-4 positions without zero 3 poles

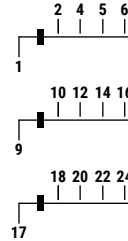
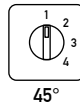

6	23-24			x	
	21-22		x		
5	19-20	x			
	17-18	x			
4	15-16			x	
	13-14		x		
3	11-12	x			
	9-10	x			
2	7-8			x	
	5-6		x		
1	3-4	x			
	1-2	x			
W	CNT	1	2	3	4

0028 • Step switch 0-1-2 positions with zero 1 pole

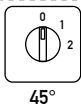

1	3-4			x
	1-2		x	
W	CNT	0	1	2

0032 • Step switch 0-1-2 positions with zero 2 poles

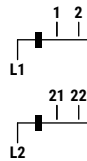
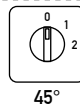

2	7-8			x
	5-6		x	
1	3-4			x
	1-2		x	
W	CNT	0	1	2

0033 • Step switch 0-1-2 positions with zero 3 poles

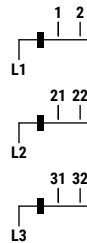

3	11-12			x
	9-10		x	
2	7-8			x
	5-6		x	
1	3-4			x
	1-2		x	
W	CNT	0	1	2

Step switches

3/3

0029 • Step switch 0-1-2-3 positions with zero 1 pole

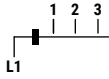
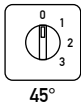

2	7-8			x	
	5-6	x			
1	1-2		x		
W	CNT	0	1	2	3

0034 • Step switch 0-1-2-3 positions with zero 2 poles

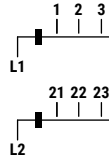
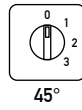

3	11-12			x	
	9-10	x			
2	7-8		x		
	5-6		x		
1	3-4			x	
	1-2	x			
W	CNT	0	1	2	3

0035 • Step switch 0-1-2-3 positions with zero 3 poles

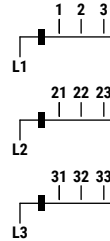
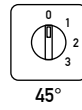

5	19-20			x	
	15-16			x	
4	13-14	x			
	11-12			x	
3	9-10	x			
	7-8		x		
2	5-6		x		
	3-4			x	
1	1-2	x			
W	CNT	0	1	2	3

0030 • Step switch 0-1-2-3-4 positions with zero 1 pole

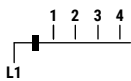
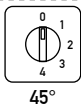

2	7-8			x		
	5-6	x				
1	3-4			x		
	1-2		x			
W	CNT	0	1	2	3	4

0036 • Step switch 0-1-2-3-4 positions with zero 2 poles

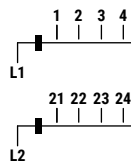
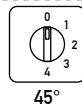

4	15-16			x		
	13-14	x				
3	11-12			x		
	9-10		x			
2	7-8			x		
	5-6	x				
1	3-4			x		
	1-2		x			
W	CNT	0	1	2	3	4

0037 • Step switch 0-1-2-3-4 positions with zero 3 poles

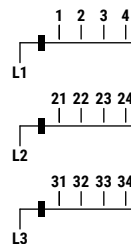
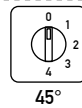

6	23-24			x		
	21-22	x				
5	19-20			x		
	17-18		x			
4	15-16			x		
	13-14	x				
3	11-12			x		
	9-10		x			
2	7-8			x		
	5-6	x				
1	3-4			x		
	1-2		x			
W	CNT	0	1	2	3	4

ACTUATORS

Cam switches / actuators matrix

Check the "Operation schemes matrix" (p.17) to identify the available operation scheme for each operator.



Series and size		P012 P016 P020	PX12 PX16 PX20	P012 P016 P020	P012 P016 P020
Terminal protection class		IP20	IP10	IP20	IP20
Mounting type		R		B	D
48x48	Grey/Black				-
screw	IP65	001/...		020/...	-
Ø 22	IP65	056X/...		095/...	-
48x48	Yellow/Red				-
screw	IP65	002/...		030/...	-
Ø 22	IP65	058X/...		070/...	-
48x48	Grey/Black padlock in 0				-
screw	IP65 / 4-4X	003/...		005/...	-
Ø 22	IP65 / 4-4X	-		077/...	-
Ø 22	IP65	059X/...		-	-
48x48	Yellow/Red padlock in 0				-
screw	IP65 / 4-4X	004/...		006/...	-
Ø 22	IP65 / 4-4X	-		069/...	-
Ø 22	IP65	060X/...		-	-
ring	Grey/Black with knob			-	-
Ø 22	IP65	028X *		-	-
ring	Grey/Black with key			-	-
Ø 22	IP65	029X *		-	-
ring 48x48	Grey/Black with key			-	-
Ø 22	IP65	057X/...		-	-
45x52	Grey/Black	-		-	
screw	-	-		-	027/...
67x67	Grey/Black max 3 padlocks				-
screw	IP65 / 4-4X	009/...		011/...	-
Ø 22	IP65 / 4-4X	-		063/...	-
Ø 22	IP65	061X/...		-	-
67x67	Yellow/Red max 3 padlocks				-
screw	IP65 / 4-4X	010/...		012/...	-
Ø 22	IP65 / 4-4X	-		064/...	-
Ø 22	IP65	062X/...		-	-

* These actuators do not have any operation scheme on the "Operation schemes matrix".

Actuator Code	ON-OFF switches 0-1			Changeover switches 1-0-2 / Motor switches						Step switches					Ammeter switches				Voltmeter switches										
	90°	90°	45°	45°	45°	60°	45°	45°	45°	45°	45°	45°	45°	45°	45°	45°	45°	45°	45°	45°	45°	45°	45°	45°	45°	45°			
001/...	0001	0001-1	0007		0008	0017	0013	0015	0015	0018	0031		0025	0028	0038	0029	0041	0030	0019	0020	0021	0022	0023	0024					
002/...	0001	0001-1	0007		0008	0017	0013	0015	0015	0018	0031		-	-	-	-	-	-	-	-	-	-	-	-	-	-	-	-	
003/...	0001	0001-1	0007		0008	0017	0013	0015	0015	0018	0031		-	-	-	-	-	-	-	-	-	-	-	-	-	-	-	-	
004/...	0001	0001-1	0007		0008	0017	0013	0015	0015	0018	0031		-	-	-	-	-	-	-	-	-	-	-	-	-	-	-	-	
005/...	0001	0001-1	-		0008	-	-	-	-	-	-		-	-	-	-	-	-	-	-	-	-	-	-	-	-	-	-	
006/...	0001	0001-1	-		0008	-	-	-	-	-	-		-	-	-	-	-	-	-	-	-	-	-	-	-	-	-	-	
007/...	0001	0001-1	0007		0008	-	0013	0015	-	0031	0031		0025	0028	0038	0029	0041	0030	-	-	-	-	-	-	-	-	-	-	
008/...	0001	0001-1	0007		0008	-	-	0015	-	0031	0031		-	-	-	-	-	-	-	-	-	-	-	-	-	-	-	-	
009/...	0001	0001-1	-		0008	0017	0013	0015	0015	0018	0031		-	-	-	-	-	-	-	-	-	-	-	-	-	-	-	-	
010/...	0001	0001-1	0007		0008	0017	0013	0015	0015	0018	0031		-	-	-	-	-	-	-	-	-	-	-	-	-	-	-	-	
011/...	0001	0001-A	-		0008	-	-	-	-	-	-		-	-	-	-	-	-	-	-	-	-	-	-	-	-	-	-	
012/...	0001	0001-2	-		0008	-	-	-	-	-	-		-	-	-	-	-	-	-	-	-	-	-	-	-	-	-	-	
020/...	0001	-	-		0008	-	-	-	-	-	-		-	-	-	-	-	-	-	-	-	-	-	-	-	-	-	-	
027/...	-	0001	-		0008	-	-	-	-	-	-		-	-	-	-	-	-	-	0019	0020	0021	-	0023	0024	-	-	-	
030/...	0001	-	-		0008	-	-	-	-	-	-		-	-	-	-	-	-	-	-	-	-	-	-	-	-	-	-	
056X/...	0001	0001-1	0007		0008	0017	0013	0015	0015	0018	0031		0025	0028	0038	0029	0041	0030	0019	0020	0021	0022	0023	0024	-	-	-	-	
057X/...	0001	0001-1	0007		0008-CA	-	0013-CA	-	-	-	-		-	0028-CA	-	0029-CA	-	-	-	-	-	-	-	-	-	-	-	-	-
058X/...	0001	0001-1	0007		0008	-	0013	-	-	-	-		-	-	-	-	-	-	-	-	-	-	-	-	-	-	-	-	
059X/...	0001	0001-1	-		0008	-	0013	-	-	-	-		-	-	-	-	-	-	-	-	-	-	-	-	-	-	-	-	
060X/...	0001	0001-1	-		0008	-	0013	-	-	-	-		-	-	-	-	-	-	-	-	-	-	-	-	-	-	-	-	
061X/...	0001	0001-1	0007		0008	-	0013	-	-	-	-		-	-	-	-	-	-	-	-	-	-	-	-	-	-	-	-	
062X/...	0001	0001-1	0007		0008	-	0013	-	-	-	-		-	-	-	-	-	-	-	-	-	-	-	-	-	-	-	-	
063/...	0001	0001-1	-		0008	-	-	-	-	-	-		-	-	-	-	-	-	-	-	-	-	-	-	-	-	-	-	
064/...	0001	0001-1	-		0008	-	-	-	-	-	-		-	-	-	-	-	-	-	-	-	-	-	-	-	-	-	-	
069/...	0001	-	-		0008	-	-	-	-	-	-		-	-	-	-	-	-	-	-	-	-	-	-	-	-	-	-	
070/...	0001	-	-		0008	-	-	-	-	-	-		-	-	-	-	-	-	-	-	-	-	-	-	-	-	-	-	
077/...	0001	-	-		0008	-	-	-	-	-	-		-	-	-	-	-	-	-	-	-	-	-	-	-	-	-	-	
095/...	0001	-	-		0008	-	-	-	-	-	-		-	-	-	-	-	-	-	-	-	-	-	-	-	-	-	-	



A series of horizontal dashed lines for writing.



A series of horizontal dashed lines spanning the width of the page, providing a template for text entry.



A series of horizontal dashed lines spanning the width of the page, providing a template for text entry.