

MZW1701

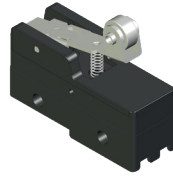

MZW1704

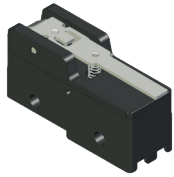

MZW1702

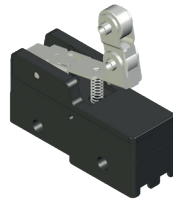

MZW1744

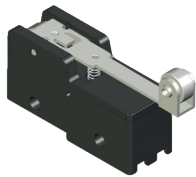

MZW1703

# MZW17...

## MICROSWITCH WITH SOLDER TERMINAL AND HINGE ACTUATOR

Microswitch  
Terminal: solder  
Actuator: hinge  
Contacts: 1 NC + 1 NO (snap action)  
Marking: CE, UL, UKCA

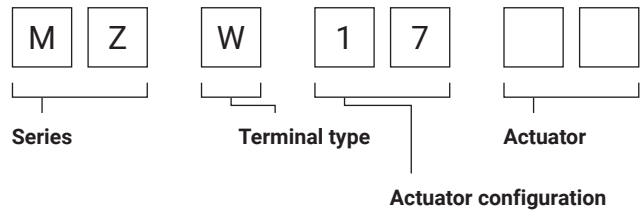

Series	Actuator
<b>MZ</b> microswitches	<b>01</b> hinge lever
	<b>02</b> short hinge lever
<b>Terminal type</b>	<b>03</b> hinge roller lever
<b>S</b> solder	<b>04</b> short hinge roller lever
	<b>44</b> unidirectional hinge roller lever
<b>Actuator configuration</b>	
<b>13</b> hinge	

Rating		
Rated contact voltage		125 250 VAC
Maximum contact current	UL61058	15 15 A
		125 250 VDC
		0.5 0.25 A
Electrical characteristics		
Maximum contact resistance	initial	15 mΩ
Minimum insulation resistance	at 500 VDC	100 MΩ
Dielectric withstanding voltage	for 1 minute	1000 VAC (50 or 60 Hz)
Mechanical characteristics		
Operating speed		0.1 mm/s ... 1 m/s
Operating frequency		30 operations per minute
Vibration		10 ... 55 Hz, 1.5 mm double amplitude
Minimum operating life	electrical	100000 cycles
	mechanical	1000000 cycles
Climatic characteristics		
Operating temperature	UL certified	0 ... +55°C (maximum humidity of 60%)
Degree of protection	with accessory	IP40

# MZW17...

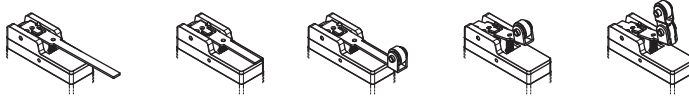

		MZW1701	MZW1702	MZW1703	MZW1704	MZW1744	
OF	max	70	90	100	160	170	g
RF	min	14	18	22	42	42	g
PT	max	10	7	7.1	2.7	2.7	mm
OT	min	5.6	3.5	4	2.4	2.4	mm
MD	max	1.27	1	1.02	0.5	0.51	mm
FP	max	28.2	26.2	36.5	32.5	43.6	mm
OP		19 ±0.8	19.8 ±0.8	30.2 ±0.8	30.2 ±0.4	41.3 ±0.8	mm

OF Operating force  
 RF Release force  
 PT Pretravel  
 OP Operating position  
 OT Overtravel  
 MD Differential movement

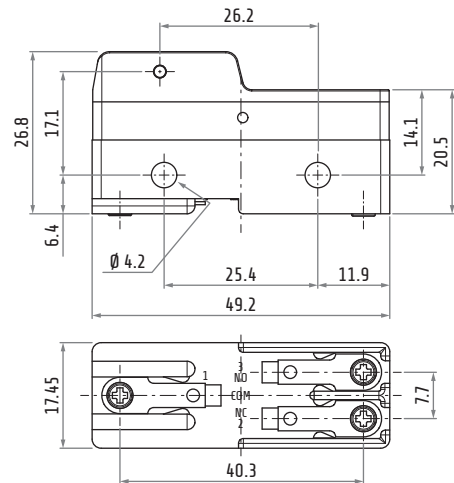
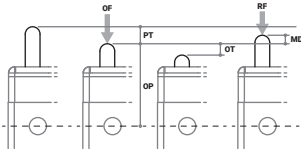

Screw mounting tightening torque: 1.2-1.5 N×m / 10.6-13.3 lb×in

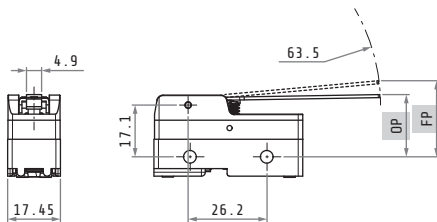

MZW1701

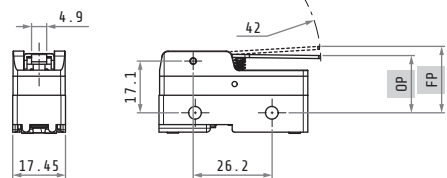

MZW1702

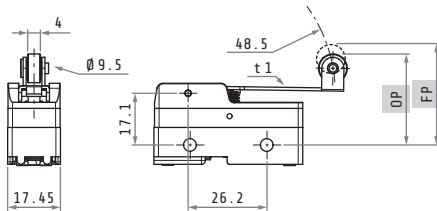

MZW1703

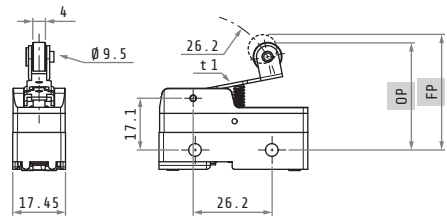

MZW1704

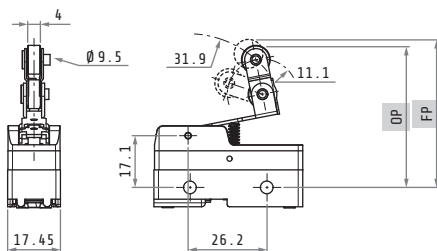

MZW1744

Dimensions in mm  
Illustrations NOT in scale

- (1) 2 hexagonal brass nuts 3×15 mm
- (2) 2 hexagonal nuts 3×17 mm
- (3) Stainless steel roller