

FCT03

LIMIT SWITCH WITH Ø12 STEEL ROLLER PLUNGER AT 90°

Thermoplastic limit switch
Horizontal action
Enclosure degree of protection: IP67
Compliance: EN60947-5-1
Marking: CE, CCC, cULus (pre-wired), cRUus (M12 connector), EAC, UKCA

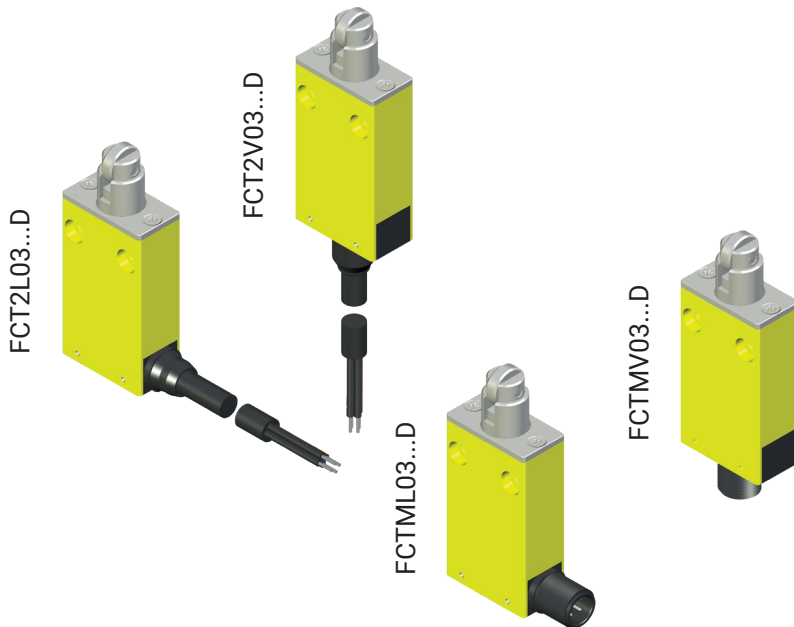
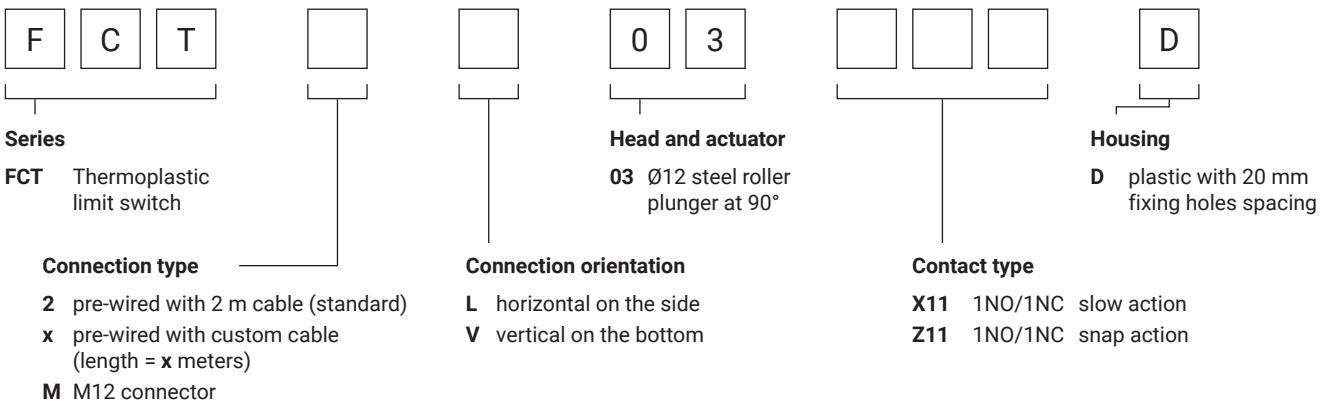

Positive opening operation	EN60947-5-1	NC contact ⊖
Rated thermal current	I _{th}	10 A pre-wired 4 A M12 connector
Rated insulation voltage		500 V AC
Rated impulse withstand voltage	U _{imp}	4 kV
Insulation resistance	min	100 MΩ (DC 500 V)
Contact resistance	max	25 mΩ (initial)
Enclosure material		self-extinguishing, shock-proof, glass fibre reinforced technopolymer
Operating temperature		-25 ... +70°C (-13 ... +158°F)
Pollution degree		3
Protection against electric shock		class II (double insulation) ▣
Mechanical life expectancy	min	1×10 ⁷ cycles
Electrical life expectancy	min	150000 cycles
Vibration	IEC 68-2-6	10-55 ±1 Hz (excursion: 0.35 mm, 1 octave/min)
Fixing		2 × M4 screws

FCT03

Contact types	Categories *	Ratings **	PT1	PT2/RP	OF	POT ⊖	POF	TT
X11 1NO 1NC slow action	A300 - Q300	AC15: 120 V - 3 A / 240 V - 1.5 A	2.0 mm	3.0 mm	12 N	3.3 mm	20 N	5.0 mm
Z11 1NO 1NC snap action		DC13: 125 V - 0.55 A / 240 V - 0.27 A	2.0 mm	0.5 mm	9.8 N	5.2 mm	24 N	5.5 mm

* UL 508 / CSA C22-2 n° 14 ** IEC/EN 60947-1

X11
slow action
1 NO + 1 NC

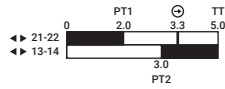
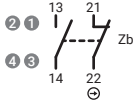

Z11
snap action
1 NO + 1 NC

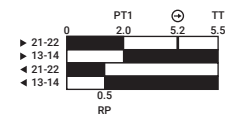
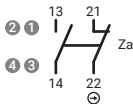

- PT1 Operating travel
- PT2 Second operating travel (slow action)
- RP Release position (snap action)
- OF Operating force
- POT Positive opening travel ⊖
- POF Positive opening force
- TT Total travel



M12 Connector pin arrangement - on request

Pre-wired connection color matching:

- 1 - Black
- 2 - Blue
- 3 - Black
- 4 - Brown

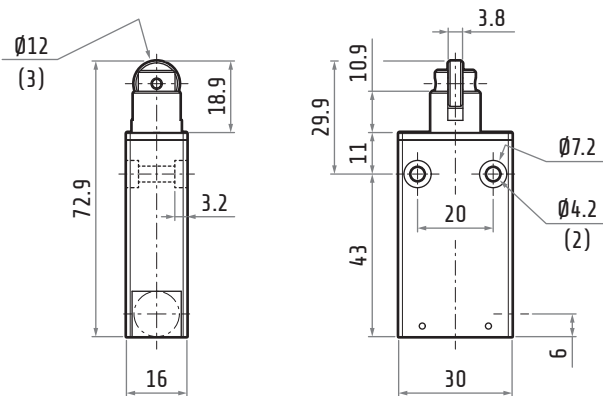

Dimensions in mm / illustrations NOT in scale

- (1) x = cable length in meters
- (2) mounting holes
- (3) steel roller

FCT2L03...D

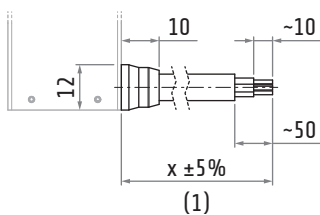

FCT2V03...D

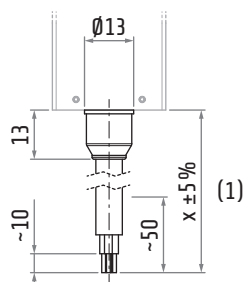

FCTML03...D

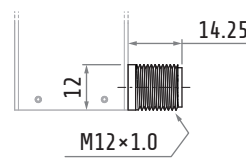

FCTMV03...D

